

**perito** ®

**AKCESORIA**

PERITO s.r.o.  
Dyje 163  
669 02 Znojmo  
tel.: +420 515 211 527  
e-mail: alu@perito.cz  
www.perito.cz





W ten sposób oznaczony pochwyty jest opcjonalnie dostępny również w wersji z LED podświetleniem (do kodu w zamówieniu dodaj „-EL/-ER”).

Np.: MD02V-EL = pochwyty z LED podświetleniem (od zewnątrz po lewej stronie)  
 MD02V-ER = pochwyty z LED podświetleniem (od zewnątrz po prawej stronie)  
 MD02V = pochwyty bez LED podświetlenia

## Pochwyty ø 30 mm (prostokątne)

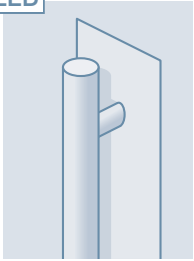

**MD02K**  
 (600 mm/**800 mm**)

**MD03K**  
 (800 mm/**1000 mm**)

**MD04K**  
 (1200 mm/**1400 mm**)

**MD05K**  
 (1300 mm/**1800 mm**)

## Pochwyty ø 30 mm (pod kątem)

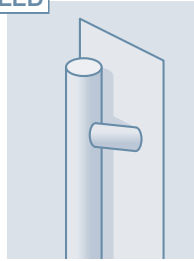

**MD02V**  
 (600 mm/**800 mm**)

**MD03V**  
 (800 mm/**1000 mm**)

**MD04V**  
 (1200 mm/**1400 mm**)

**MD05V**  
 (1300 mm/**1800 mm**)

## Pochwyty 40 × 20 mm (pod kątem)

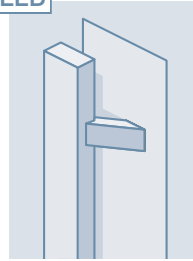

**MD30V**  
 (600 mm/**800 mm**)

**MD31V**  
 (800 mm/**1000 mm**)

**MD32V**  
 (1000 mm/**1200 mm**)

**MD33V**  
 (1200 mm/**1400 mm**)

## Pochwyty 40 × 20 mm (prostokątne)

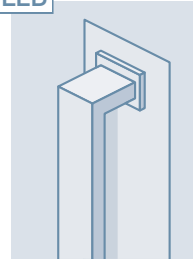

**MD48K**  
 (280 mm/**300 mm**)

**MD49K**  
 (480 mm/**500 mm**)

**MD50K**  
 (780 mm/**800 mm**)

**MD51K**  
 (980 mm/**1000 mm**)

**MD55K**  
 (1180 mm/**1200 mm**)

## Pochwyty 40 × 10 mm (prostokątne)

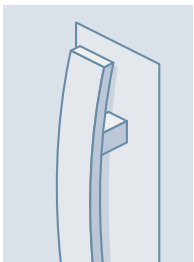

**MD52K**  
 (300 mm/**600 mm**)

**MD54K**  
 (1500 mm (900 mm)  
 /**1800 mm**)

## Pochwyty 40 × 40 mm (prostokątne)

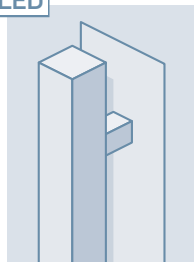

**MD13K**  
 (300 mm/**500 mm**)

**MD14K**  
 (600 mm/**800 mm**)

**MD15K**  
 (800 mm/**1000 mm**)

**MD16K**  
 (1200 mm/**1400 mm**)

**MD17K**  
 (1600 mm/**1800 mm**)

## Pochwyty 40 × 20 mm (prostokątne)

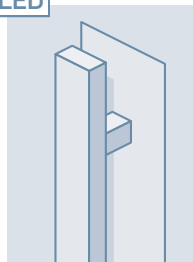

**MD38K**  
 (600 mm/**800 mm**)

**MD39K**  
 (800 mm/**1000 mm**)

**MD40K**  
 (1000 mm/**1200 mm**)

**MD41K**  
 (1200 mm/**1400 mm**)

## Pochwyty 40 × 40 mm (prostokątne)

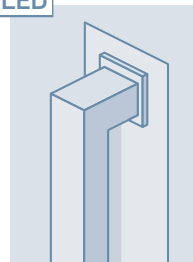

**MD56K**  
 (760 mm/**800 mm**)

**MD57K**  
 (960 mm/**1000 mm**)

**MD58K**  
 (1360 mm/**1400 mm**)

**MD59K**  
 (1760 mm/**1800 mm**)



Wszystkie akcesoria zilustrowane na tej stronie są ze stali nierdzewnej w wykończeniu matowym (szlifowanym).

# klamki i rozety ze stali nierdzewnej

## Rozety zewnętrzne



RE02HP



RE030P



RER2



RER6

## Rozety wewnętrzne



RI010V



RI02HV

## Klamki rozetowe

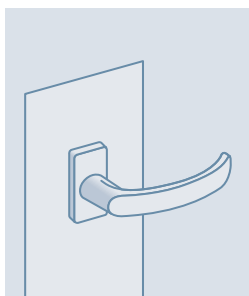

KL01RO



KL02RO



KL03RO



KL05RO



KL06RO



KL08RH



KL09RH

## Gałki rozetowe



MD19VKOUL



MD28VKOUL

## Klamki na długim szyldzie



GS01ZA



GS02ZA



GS03ZA



KL07RS

**i** Wszystkie akcesoria zilustrowane na tej stronie są ze stali nierdzewnej w wykończeniu matowym (szlifowanym).  
Dla dostawy konieczna informacja o grubości skrzydła.



W ten sposób oznaczony pochwyty jest opcjonalnie dostępny również w wersji z LED podświetleniem (do kodu w zamówieniu dodaj „-EL/-ER”).

Np.: MDB02V-EL = pochwyty z LED podświetleniem (od zewnątrz po lewej stronie)  
 MDB02V-ER = pochwyty z LED podświetleniem (od zewnątrz po prawej stronie)  
 MDB02V = pochwyty bez LED podświetlenia

## Pochwyty ø 30 mm (prostokątne)

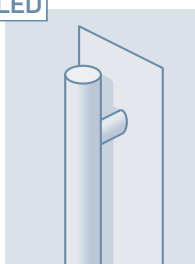

- MDB02K**  
(600 mm/**800 mm**)
- MDB03K**  
(800 mm/**1000 mm**)
- MDB04K**  
(1200 mm/**1400 mm**)

## Pochwyty ø 30 mm (pod kątem)

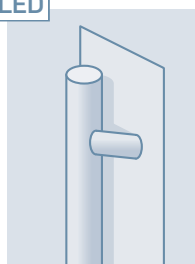

- MDB02V**  
(600 mm/**800 mm**)
- MDB03V**  
(800 mm/**1000 mm**)
- MDB04V**  
(1200 mm/**1400 mm**)

## Pochwyty 40 × 20 mm (pod kątem)

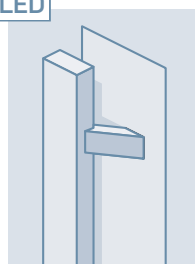

- MDB30V**  
(600 mm/**800 mm**)
- MDB31V**  
(800 mm/**1000 mm**)
- MDB32V**  
(1000 mm/**1200 mm**)
- MDB33V**  
(1200 mm/**1400 mm**)

## Pochwyty 40 × 20 mm (prostokątne)

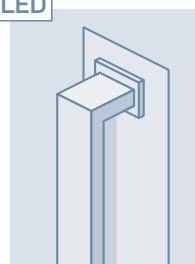

- MDB48K**  
(280 mm/**300 mm**)
- MDB49K**  
(480 mm/**500 mm**)
- MDB50K**  
(780 mm/**800 mm**)
- MDB51K**  
(980 mm/**1000 mm**)
- MDB55K**  
(1180 mm/**1200 mm**)



Wszystkie akcesoria ilustrowane na tej stronie są wykonane z aluminium i malowane proszkową farbą (RAL 9005 mat – INVER 49940).

Wykończenie powierzchni farbą proszkową jest bardziej skłonne na zarysowania. Uszkodzenie mechaniczne podczas normalnego stosowania nie może być przedmiotem reklamacji.

## Pochwyty 40 × 40 mm (prostokątne)

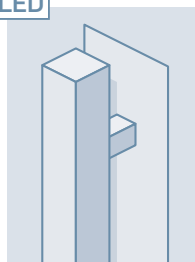

- MDB13K**  
(300 mm/**500 mm**)
- MDB14K**  
(600 mm/**800 mm**)
- MDB15K**  
(800 mm/**1000 mm**)
- MDB16K**  
(1200 mm/**1400 mm**)
- MDB17K**  
(1600 mm/**1800 mm**)

## Pochwyty 40 × 20 mm (prostokątne)

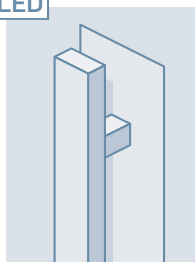

- MDB38K**  
(600 mm/**800 mm**)
- MDB39K**  
(800 mm/**1000 mm**)
- MDB40K**  
(1000 mm/**1200 mm**)
- MDB41K**  
(1200 mm/**1400 mm**)

## Pochwyty 40 × 40 mm (prostokątne)

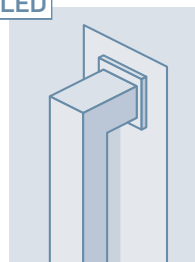

- MDB56K**  
(760 mm/**800 mm**)
- MDB57K**  
(960 mm/**1000 mm**)
- MDB58K**  
(1360 mm/**1400 mm**)
- MDB59K**  
(1760 mm/**1800 mm**)

# specjalne pochwyty i inne akcesoria



W ten sposób oznaczony pochwyty jest opcjonalnie dostępny również w wersji z LED podświetleniem (do kodu w zamówieniu dodaj „-EL/-ER”).

Np.: MD45V-EL = pochwyty z LED podświetleniem (od zewnątrz po lewej stronie)  
MD45V-ER = pochwyty z LED podświetleniem (od zewnątrz po prawej stronie)  
MD45K = pochwyty bez LED podświetlenia

## Pochwyty 40 × 20 mm z czytnikiem linii papilarnych eKey ARTE

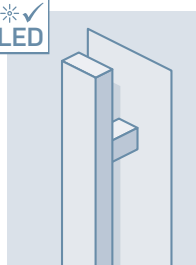

**MD45K**  
(1000 mm/1200 mm)

**MD46K**  
(1200 mm/1600 mm)

**MD47K**  
(1300 mm/1800 mm)

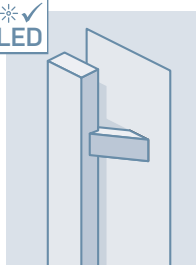

**MD45V**  
(1000 mm/1200 mm)

**MD46V**  
(1200 mm/1600 mm)

**MD47V**  
(1300 mm/1800 mm)

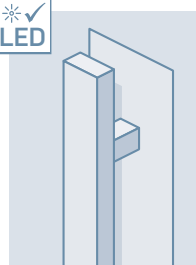

**MDB45K**  
(1000 mm/1200 mm)

**MDB46K**  
(1200 mm/1600 mm)

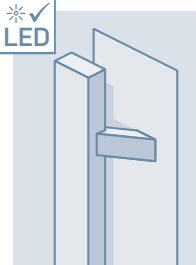

**MDB45V**  
(1000 mm/1200 mm)

**MDB46V**  
(1200 mm/1600 mm)



Pokazane pochwyty są w czarnej farbie proszkowej (RAL 9005 – INVER 4-9940)

## Pochwyty 40 × 40 mm drewno (prostopadłe)

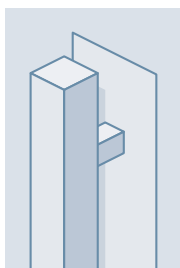

**MD34K**  
(800 mm/1000 mm)

**MD35K**  
(1000 mm/1200 mm)

## Pochwyty ø 40 mm drewno (prostopadłe)

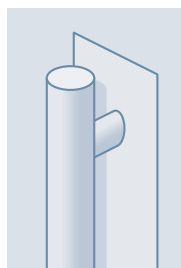

**MD36K**  
(1000 mm/1200 mm)

**MD37K**  
(1400 mm/1600 mm)

## Specjalne pochwyty (mat)



## Wrzutki na listy

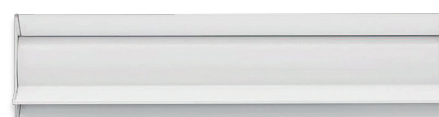

**VH01WH**



**VH02E1B**

(Inne kolory wykonania wrzutek na listy na zapytanie)

**MD20B** (600 mm/800 mm)

**MD21B** (1000 mm/1200 mm)

**MD22B** (1200 mm/1600 mm)

MD20B, MD21B, MD22B = pochwyty do montażu bezpośredniego w korpusie wypełnienia

## Klamki



KLB11RH



KLB12RH



MDB13KH



MDB14KH

## Rozety zewnętrzne



REBR2



REBR6

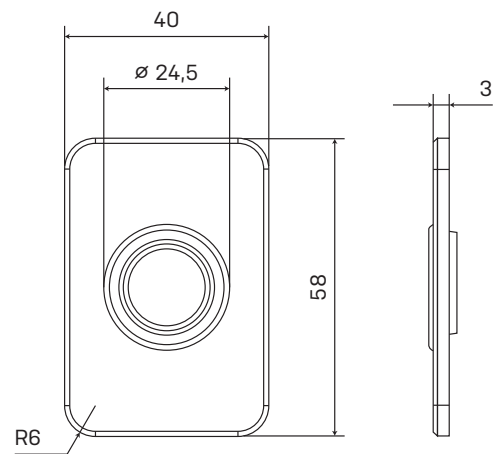
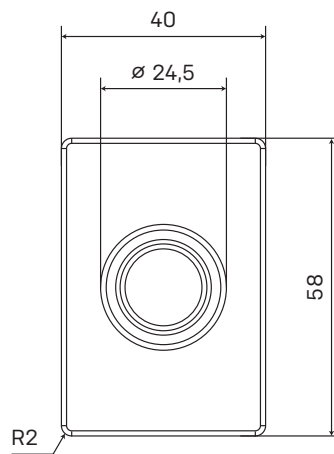

## Rozety wewnętrzne/zewnętrzne



REB11HV

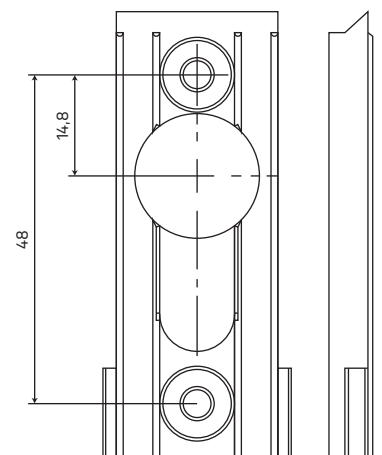
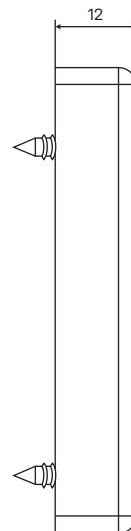
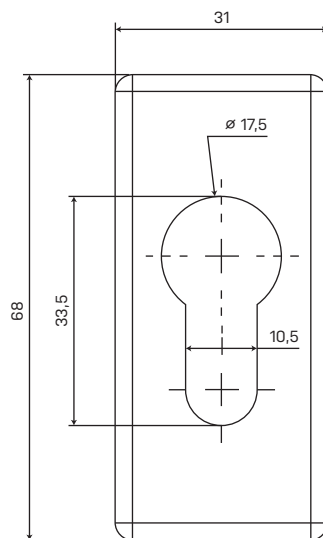
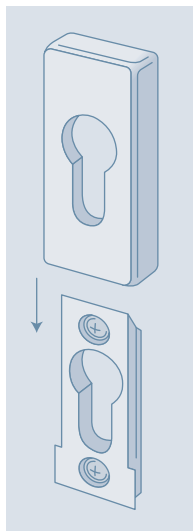

Wszystkie akcesoria ilustrowane na tej stronie są w czarnym kolorze, farba proszkowa (RAL 9005 mat – INVER 49940). Wykończenie powierzchni farbą proszkową jest bardziej skłonne na zarysowania. Uszkodzenie mechaniczne podczas normalnego stosowania nie może być przedmiotem reklamacji.

# specjalne pochwyty kieszeniowe INOX/STAL nierdzewna



W ten sposób oznaczony pochwyty jest opcjonalnie dostępny również w wersji z LED podświetleniem (do kodu w zamówieniu dodaj „-EL/-ER”).

Np.: MDZ1-EL = pochwyty z LED podświetleniem (od zewnątrz po lewej stronie)  
MDZ1-ER = pochwyty z LED podświetleniem (od zewnątrz po prawej stronie)  
MDZ1 = pochwyty bez LED podświetlenia

## Pochwyty kieszeniowe ukryte

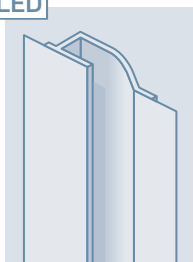

**MDZ1**  
(61×800 mm)

**MDZ2**  
(61×1200 mm)

**MDZ3**  
(61×1600 mm)

**MDZ4**  
(61×2000 mm)

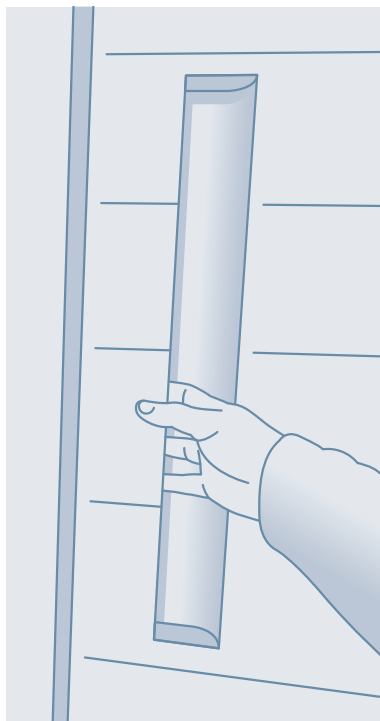

Ilustracja osadzenia pochwyty w korpusie wypełnienia



Pochwyty kieszeniowe są w wykonaniu INOX.

## Pochwyty kieszeniowe z panelem czołowym

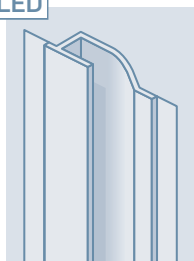

Wszystkie pochwyty kieszeniowe z panelem czołowym są ze stali nierdzewnej w wykonaniu matowym (szlifowane), część wewnętrzna w wykonaniu INOX.



**MDM1**  
(200×200 mm)



**MDM2**  
(250×150 mm)



**MDM3**  
(155×550 mm)



**MDM5**  
(400×115 mm)



**MDM4**  
(185×1400 mm)



# specjalne pochwyty kieszeniowe w czarnym kolorze



W ten sposób oznaczony pochwyty jest opcjonalnie dostępny również w wersji z LED podświetleniem (do kodu w zamówieniu dodaj „-EL/-ER”).

Np.: MDBZ1-EL = pochwyty z LED podświetleniem (od zewnątrz po lewej stronie)  
MDBZ1-ER = pochwyty z LED podświetleniem (od zewnątrz po prawej stronie)  
MDBZ1 = pochwyty bez LED podświetlenia

## Pochwyty kieszeniowe ukryte

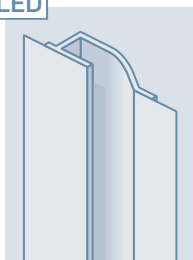

- MDBZ1**  
(61×800 mm)
- MDBZ2**  
(61×1200 mm)
- MDBZ3**  
(61×1600 mm)
- MDBZ4**  
(61×2000 mm)

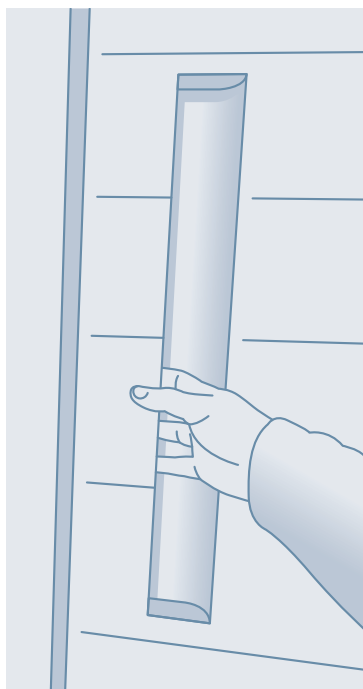

Ilustracja osadzenia pochwyty w korpusie wypełnienia



Wszystkie akcesoria ilustrowane na tej stronie są w czarnym kolorze, farba proszkowa (RAL 9005 mat – INVER 49940). Wykończenie powierzchni farbą proszkową jest bardziej skłonne na zarysowania. Uszkodzenie mechaniczne podczas normalnego stosowania nie może być przedmiotem reklamacji.

## Pochwyty kieszeniowe z panelem czołowym

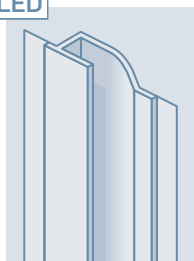

**MDBM1**  
(200×200 mm)



**MDBM2**  
(250×150 mm)



**MDBM3**  
(155×550 mm)



**MDBM5**  
(400×115 mm)



**MDBM4**  
(185×1400 mm)



Wszystkie akcesoria ilustrowane na tej stronie są w czarnym kolorze, farba proszkowa (RAL 9005 mat – INVER 49940). Wykończenie powierzchni farbą proszkową jest bardziej skłonne na zarysowania. Uszkodzenie mechaniczne podczas normalnego stosowania nie może być przedmiotem reklamacji.

## Klamki i rozety



**KLB21R0**



**MDB23KO**



**KLB22RH**

## Rozety wewnętrzne/zewnętrzne



**RIB210V**



**RIB22HV**

## Półokrągłe pochwyty (prostopadłe)

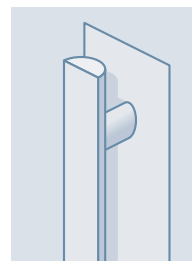

**MDB60K**  
(560 mm/800 mm)

**MDB61K**  
(700 mm/1000 mm)

**MDB62K**  
(900 mm/1200 mm)



## Półokrągłe pochwyty (prostopadłe)

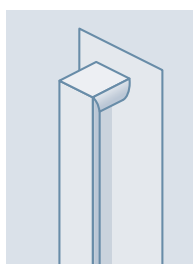

**MDB63K**  
(600 mm/623 mm)

**MDB64K**  
(800 mm/823 mm)

**MDB65K**  
(1000 mm/1023 mm)

**MDB66K**  
(1200 mm/1223 mm)



## Pochwyty Ø 30 mm (prostopadłe)

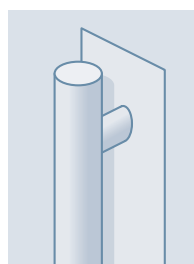

**MDB67K**  
(560 mm/800 mm)

**MDB68K**  
(700 mm/1000 mm)

**MDB69K**  
(900 mm/1200 mm)

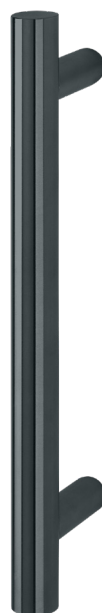

## Pochwyty 35 × 35 mm (prostopadłe)

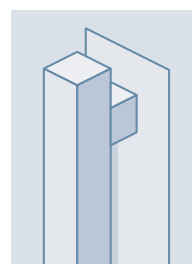

**MDB70K**  
(400 mm/600 mm)

**MDB71K**  
(560 mm/800 mm)

**MDB72K**  
(900 mm/1200 mm)



Wszystkie akcesoria ilustrowane na tej stronie są w czarnym kolorze od firmy HOPPE pod oznaczeniem farby F9714M

Termin dostawy akcesorii HOPPE aż 5 tygodni od przyjęcia zamówienia





[www.perito.pl](http://www.perito.pl)

---